



Preface

- Thank you for purchasing WWW.BEZKLICU.CZ Platinum Fingerprint Theft–Proof Door Lock.
- Please read this user’s manual carefully.
- The manufacturer will not be responsible for any damages caused by improper use.

Please write down the serial number on the line below, you can find it on the side of package easily.

SN: _____



Contents

1. Main Character.....	3
2. Unit descriptions.....	3
3. Installation.....	4
3.1 Preparation before installation	4
3.2 Parts composition.....	5
3.3 Diagram of the lock installation holes.....	5
4. Pre-setting up.....	6
4.1 Proper finger positioning.....	6
4.2 Battery installation and replacement.....	6
5. Setup and Operation.....	7
5.1 Save Fingerprint.....	7
5.1.1 Save Administrator's Fingerprint.....	8
5.1.2 Save User's Fingerprint.....	9
5.2 Delete Fingerprint.....	10
5.2.1 Delete fingerprints of the user level one by one.....	10
5.2.2 Delete all of the saved user level fingerprint.....	11
5.3 Delete the administrator fingerprint	11
6. Opening the Door.....	12
7. Locking the Door.....	12
8. Non-disturbance.....	13
9. Using an override key.....	14
10. Key notes.....	15
11. Specifications.....	16

1. Main Character

- a. Easy installation and operation
- b. High security
- c. Management in two levels
- d. High efficiency and saved energy
- e. Low battery prompt
- f. Non-disturbance
- g. Override function

2. Unit descriptions

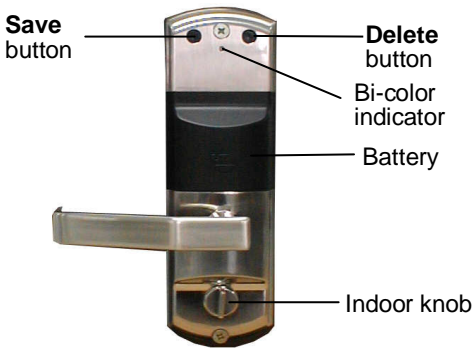

Inside unit

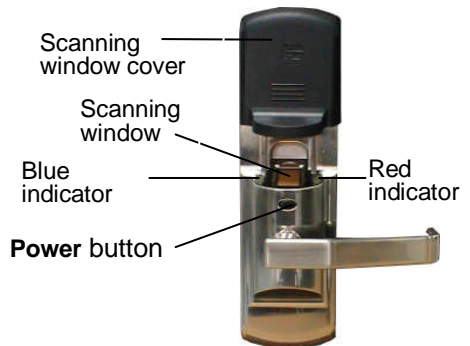

Outside unit

3. Installation

3.1 Preparation before installation

The lock handle direction must be correspond to the one of door opening. If not, you should ask the dealer to exchange it as per a suitable handle direction (refer to Figure 1).

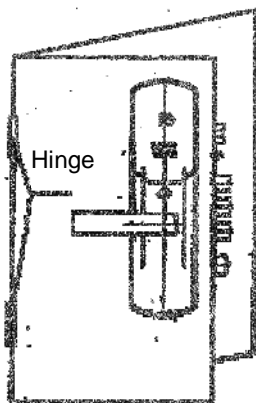

Left-handle

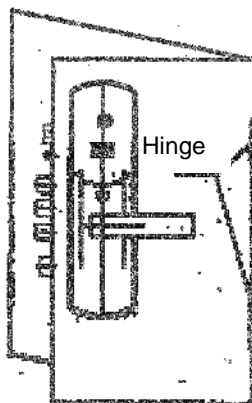

Right-handle

☆ **Note: How to determine the door opening direction?**

Stand outdoors and face to the door: If the hinge is at the left side of the door, the door is a left-handed one and the left-handed lock can be used.

If the hinge is at the right side of the door, the door is a right-handed one and the right-handed lock can be used.

3.2 Parts composition

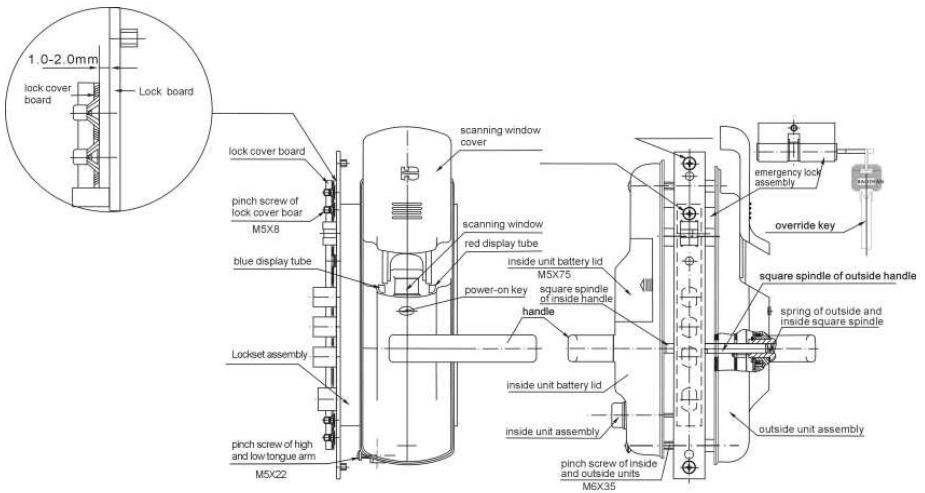

3.3 Diagram of the lock installation holes

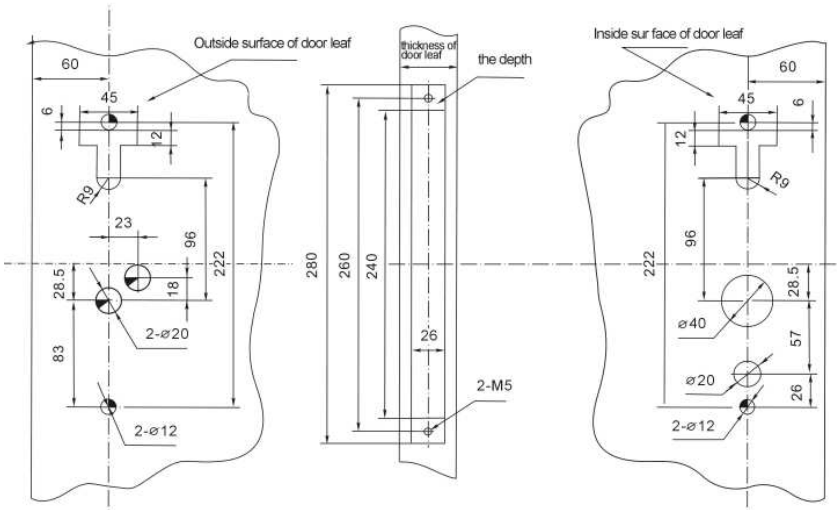

Note: the draft is for right-handed door. The left-handed door is on the back.

4. Pre-setting up

4.1 Proper finger positioning

Place a finger on the center of the scanning window, press slightly and keep it unmovable.

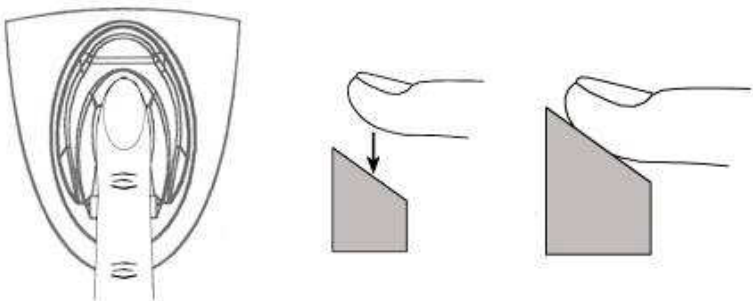

4.2 Battery installation and removal



Pull battery cover away, put 4 AA alkaline cells into the cell box by way of a correct polar direction. Then fasten the battery cover tightly.



Remove battery cover

Put 4 AA cells

Battery is installed

Fasten the battery cover

5. Setup and Operation

The system provides two management levels: 2 Administrative level and User level: 13 users (the save capacity of the system is 15 users in total, and the system can save 2 fingerprints for each administrator and each user).

Authority/name	Administrator level	User level
Save/delete fingerprint	√	



Open the door	√	√
---------------	---	---

5.1 Save Fingerprint

Setting at factory:



①

Slide up the scanning window cover before operating. There is no fingerprint in the lock loaded from manufacturer.



②

Press **Power** button, the lockset will unlock automatically. Turn the handle to open the door.

5.1.1 Save Administrator's Fingerprint

(1) Save Administrator's Fingerprint



①

Press **Power** button.



②

Press the **Save** button and hold it for 3 seconds. After hearing a beep and the red light goes on, the system enters saving fingerprint status.



③

The administrator places his finger on scanning window center to scan. Red light goes off. Remove the finger. Hearing a prompt toot, red lamp goes on at the same time. Reposition the finger for the second scan.



④

The blue light goes on as hearing 2 beeps, the fingerprint is saved successfully. (If you find a red indicator goes on, i.e. the saving is failure. The system is powered off then.

Note:

While entering operational status, if there fails to save or delete within 15 seconds, the system will power off automatically.

The first two saved fingerprints in the system are administrator's fingerprints. Saving of each administrator fingerprint is successful, the system will automatically power off to verify the present administrator fingerprint. When the verification is successful, you can go on taking the next step for saving or deleting.



(2) Verify Administrator Fingerprint



①

Press **Power** button to power on the system.



②

When the red light is on, the administrator places his finger on the scanner window center to verify fingerprint.



③

When the blue light goes on, the lockset is unlocked, i.e. the verification is successful. When red lamp goes on, i.e. the verification is failure.



④

When the administrator fingerprint verification is successful, the system enters the operational status. If there is no operation within 6 seconds, the system will power off.

5.1.2 Save User Fingerprint



①

Power on the system. The administrator places his finger on the scanning window center to verify fingerprint. Blue lamp goes on, it means verification is successful.



②

Before the system is powered off, press the save key and hold it firmly. When hearing a prompt toot and see red lamp goes on, the system enters fingerprint save status.



③

Place a finger on scanning window center to scan fingerprint. When red lamp on outside unit goes off, remove the finger. When hearing a prompt toot again, red lamp goes on, place the finger again to save the second fingerprint. Blue lamp goes on, meaning fingerprint saving is successful.



④

By the time when the system is working, press the save key and hold it firmly to save fingerprint continually. 3 prompt toots mean the fingerprints have already been saved fully.



Suggestion

After the user fingerprint is saved, exit the system immediately. Please power on the system again to verify the saved fingerprint and see whether the save is successful. If the save is successful, save the other users fingerprint continually.

5.2 Delete Fingerprint

5.2.1 Delete fingerprints of the user one by one.



①

Power on the system. After the administrator fingerprint verification is successful, blue lamp goes on and the system enters operational status.



②

Press delete key and hold it for 3 seconds. After blue lamp goes on and hearing 2 prompt toots, the last saved fingerprint from user is deleted; continually press delete key, users fingerprints will be deleted in proper order. When hear 3 prompt toots, all of the user's fingerprints are deleted.

5.2.2 Delete all of the saved user level fingerprints



①

Power on the system. After the administrator fingerprint verification is successful, blue lamp goes on and the system enters operational status.



②

Press both save key and deletion key at the same time and hold them firmly. When hearing 2 prompt toots, all of saved fingerprints from users are deleted.

5.3 Delete the administrator's fingerprint



If there are only the Administrators fingerprints in the system, press **Power** and **Delete** buttons at the same time. When hearing a prompt toot, the administrator's fingerprints are deleted and the system is powered off and resumes its original.

6. Opening the Door

Outdoors



①

Press **Power** button to power on the system.



②

Red indicator goes on; place the finger on scanning window center. Blue indicator goes on; when hearing 2 prompt toots, the lockset unlocked and then turn handle to open the door.

Indoors

Turn handle of inside unit, the lockset is unlocked.